













NAOK Series 3.2 x 2.5

| | |
|--|---|
|    | Application : <ul style="list-style-type: none">  Typically used for real time clock application  Mobile Phone / Set-top Box  Notebook PC / Portable PC  Car navigation systems  Wireless LAN |
| | Features : <ul style="list-style-type: none">  Meet clock signal for tight tolerance requirement  Tight symmetry (45 to 55%) available  Low Power Consumption  Tri-state enable / disable  Excellent solderability |

Electrical Specification :

| Model | | NAOK-32 | | |
|-----------------------------|--------|------------------------------------|---------|---------|
| Frequency Range | KHz | 32.768 | | |
| Oscillation Mode | | Fundamental | | |
| Output Type | | CMOS | | |
| Output Load | pF | 15 | | |
| Frequency Stability | PPM | A: ±100 B: ±50 C: ±30 D: ±25 | | |
| Operating Temp Range | °C | -20 ~ +70 or specify | | |
| Storage Temp Range | °C | -55 ~ +125 | | |
| Power Supply Voltage | VDC | 3.3V±10% | 2.5V±5% | 1.8V±5% |
| Voltage Vol / Voh | % | 10% VDD (Max) / 90% VDD (Min) | | |
| Output Symmetry | | 40% ~ 60% or 45% ~ 55% (at 55%VDC) | | |
| Tri-state Voltage Vol / Voh | | 0.3 VDD / 0.7 VDD | | |
| Start Time | mS | 10 | | |
| Current Consumption | uA | 240 (Max) | | |
| Rise and Fall Time | nS max | 200 (Max) | | |

* Above specification subject to change without prior notice, please consult our sales representative for more information*

TAIWAN — JENJAAN QUARTEK CORPORATION

Address : 3F-5, No 504 Yun Shan Road, Chung Ho City, Taipei, Taiwan
 Tel : +886-2-8221-4498 Fax : +886-2-8221-4499
 E-mail : jjenjaan@jenjaan.com.tw Web : http://www.nsk.com.tw

FACTORY - DONG GUAN ALLIED PROJECT LIMITED

Address : No. 703, Fu Min Zhong Road, Yang Yong Village, Dalang
 Town, Dong Guan, Guang Dong, China Tel : +86-769-8311-9395
 Fax : +86-769-8313-0880 E-mail : alliedj@pub.dgnet.gd.cn

Dimensions (mm) :

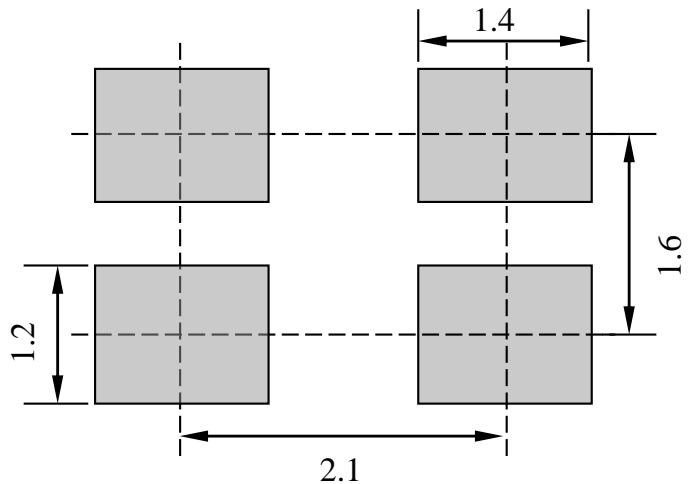
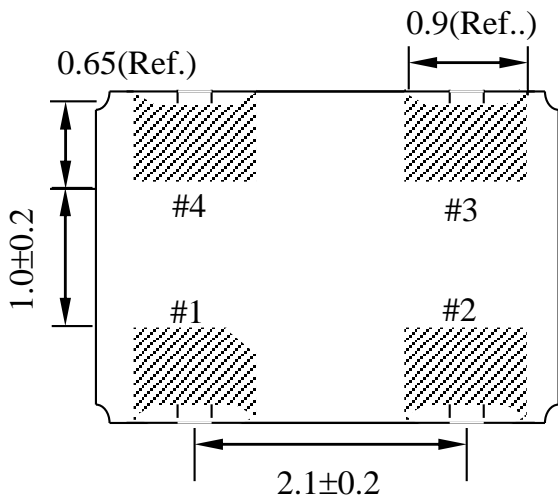
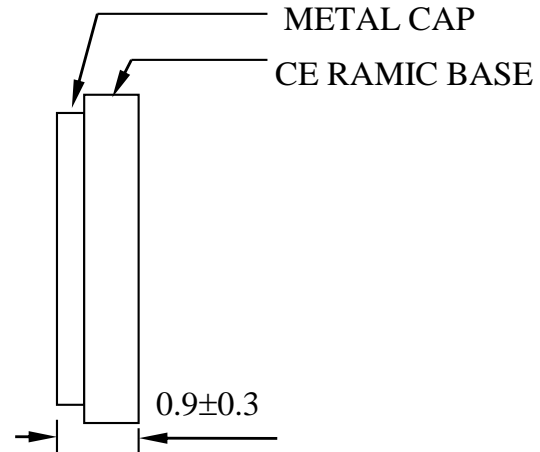
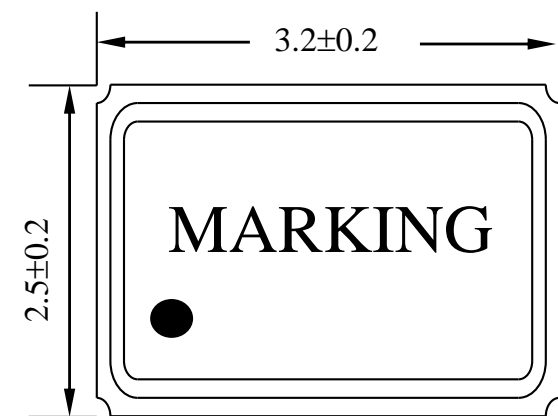

#1: ENABLE / DISABLE FUNCTION

| | | | | |
|-------------|-------|----------------|---------------|------------|
| INH (PIN 1) | ————→ | OUTPUT (PIN 3) | # NO.: define | |
| High (OPEN) | ————→ | Operating | #4: VDD | #3: OUTPUT |
| LOW | ————→ | High impedance | #1: E/D | #2: GND |

* Above specification subject to change without prior notice, please consult our sales representative for more information*

TAIWAN — JENJAAN QUARTEK CORPORATION

Address : 3F-5, No 504 Yun Shan Road, Chung Ho City, Taipei, Taiwan
 Tel : +886-2-8221-4498 Fax : +886-2-8221-4499
 E-mail : jenjaan@jenjaan.com.tw Web : http://www.nsk.com.tw

FACTORY - DONG GUAN ALLIED PROJECT LIMITED

Address : No. 703, Fu Min Zhong Road, Yang Yong Village, Dalang
 Town, Dong Guan, Guang Dong, China Tel : +86-769-8311-9395
 Fax : +86-769-8313-0880 E-mail : alliedj@pub.dgnet.gd.cn

Tape Specification(mm) :

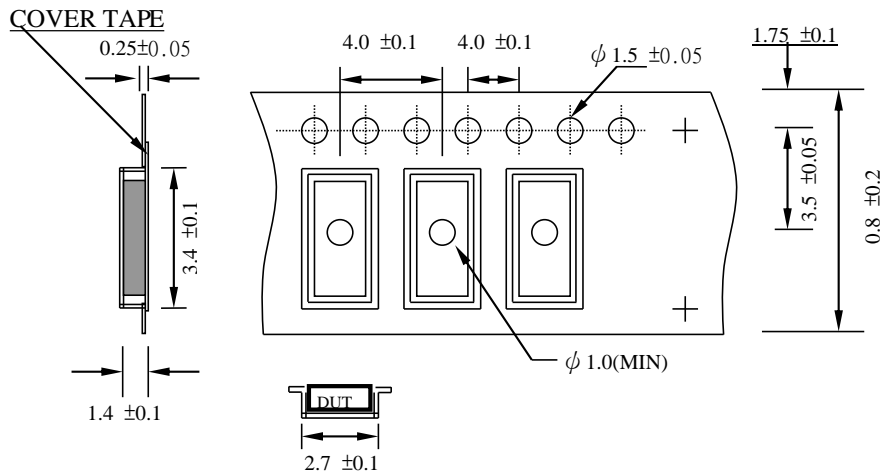

Reel Packing(mm) :

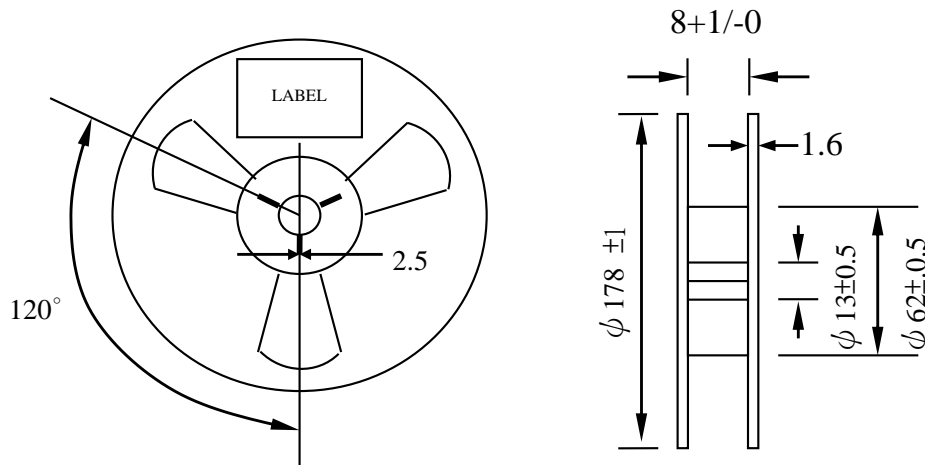

Reflow Temperature Profile :

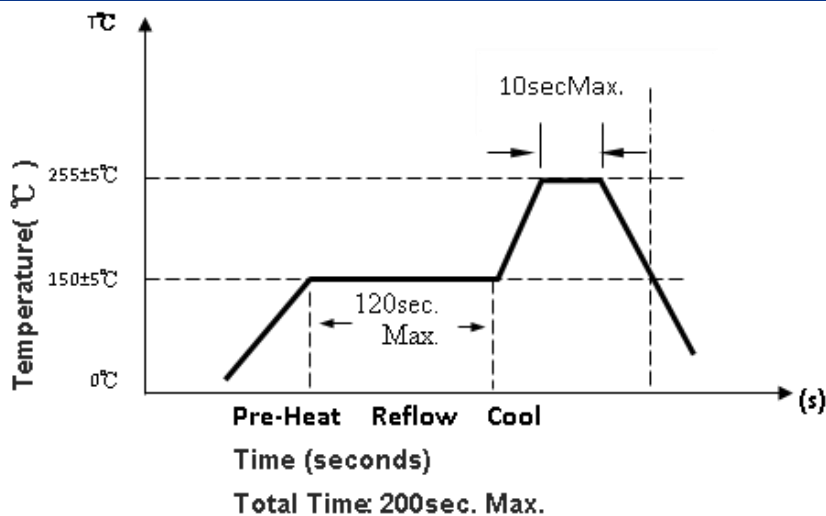

* Above specification subject to change without prior notice, please consult our sales representative for more information*

TAIWAN — JENJAAN QUARTEK CORPORATION

Address : 3F-5, No 504 Yun Shan Road, Chung Ho City, Taipei, Taiwan

Tel : +886-2-8221-4498

E-mail : jjenjaan@jenjaan.com.tw

Fax : +886-2-8221-4499

Web : <http://www.nsk.com.tw>

FACTORY - DONG GUAN ALLIED PROJECT LIMITED

Address : No. 703, Fu Min Zhong Road, Yang Yong Village, Dalang

Town, Dong Guan, Guang Dong, China Tel : +86-769-8311-9395

Fax : +86-769-8313-0880

E-mail : alliedj@pub.dgnet.gd.cn